

FED20 SERIES

DC / DC Single & Dual Output: 20 Watts



Features

- 2:1 standard input range
- Input options: 12V, 24V and 48VDC
- Single & Dual outputs
- Industry Standard 2 x 1in package
- High efficiency up to 83%
- Regulated output & Short circuit protection
- 1600V isolation
- Five sided continuous copper shield
- Remote ON / OFF: Positive Logic standard.
- Remote ON / OFF: Negative Logic - **option**
- High operating temperature +85°C
- Fixed switching frequency
- Safety EN60950, UL1950
- EMC compliance

Specifications:

Input Voltage	12VDC (9 ~ 18) 24VDC (18 ~ 36) 48VDC (36 ~ 75)	Efficiency	Model dependant 78% ~ 88%
Input Filter	L-C type	Isolation	1600VDC
Input Surge Voltage. (100mS)	12V: 36VDC 24V: 50VDC. 48V: 100VDC	Isolation Cap.	1000pF
Input Reflected Ripple Current	20mA pk-pk (@ nominal input & 100% load	Switching Freq.	500KHz
Start Up time	10mS constant resistive load	Safety	EN60950-1, UL60950-1
Remote ON/OFF (Positive logic -standard) (Negative logic - Option)	DC-DC ON Open or $3.0V < V_r < 12V$ DC-DC OFF Short or $0V < V_r < 1.2V$ DC-DC ON Short or $0V < V_r < 1.2V$ DC-DC OFF Open or $3.0V < V_r < 12V$ Input current of remote control pin: 1mA Remote off state input current: 2.5mA	Case Material	Nickel-coated copper
Output power	20 watts	Base Material	Non-conductive black plastic
Voltage Accuracy	±1.0%	Potting	Epoxy UL94-V0
Voltage Trim	±10% via external resistor network (Single only)	Dimensions	50.8 x 25.4 x 10.2mm
Minim Load	Zero	Weight	27g
Line Regulation	Single ±0.2% Dual ±0.2%	MTBF	1.791 x 10 ⁶ Hrs
Load Regulation	Single ±0.5% , Dual ±1% (0% -100% load)	Operating Temp	Standard: -40°C to +85°C (with derating)
Cross Regulation	±5% Asymmetrical load: 25-100% load)	Case Temp	+100°C maximum case temperature
Ripple & noise	See table. 20MHZ bandwidth	Thermal Impedance	12°C / watt Standard convection 10°C / watt with optional heatsink
Temp. Coefficient	±0.02% / °C	Thermal shock	MIL-STD-810F
Transient Response	250uS (25% load step change)	Vibration	10-55Hz, 10G, 30min along X, Y,Z
Over Voltage Protection	1.5V~ 3.3V: 3.9V 5.0V: 6.2V 12V: 15V 15V: 18V	Humidity	5-95% RH
Overload Protection	Typically 150% of load	EMC	EN55022 Class A Consult office for Class B design
Short Circuit protection	Continuous hiccup mode	ESD	EN61000-4-2
		Radiated Immunity	EN61000-4-3
		Fast Transients	EN61000-4-4
		Surge	EN61000-4-5
		Conducted Immunity	EN61000-4-6

FED20 SERIES

DC / DC Single & Dual Output: 20 Watts

Model V	Input V	Output V	Output Current		Output Ripple & Noise	Input Current		Eff (%)	Capacitor Load max
			Min. load	Full load		No load	Full load		
FED20-12S1P5	9 – 18 V	1.5 V	0mA	6000mA	60mVp-p	70mA	1014mA	78	65000uF
FED20-12S1P8	9 – 18 V	1.8 V	0mA	6000mA	60mVp-p	75mA	1200mA	79	65000uF
FED20-12S2P5	9 – 18 V	2.5 V	0mA	6000mA	60mVp-p	80mA	1582mA	83	33000uF
FED20-12S3P3	9 – 18 V	3.3 V	0mA	5000mA	60mVp-p	115mA	1698mA	85	13000uF
FED20-12S05	9 – 18 V	5 V	0mA	4000mA	75mVp-p	75mA	2008mA	87	6800uF
FED20-12S12	9 – 18 V	12 V	0mA	1670mA	75mVp-p	90mA	2037mA	86	2200uF
FED20-12S15	9 – 18 V	15 V	0mA	1330mA	75mVp-p	35mA	2027mA	86	755uF
FED20-12D12	9 – 18 V	±12V	0mA	±833mA	100mVp-p	45mA	2032mA	86	±680uF
FED20-12D15	9 – 18 V	±15V	0mA	±667mA	100mVp-p	50mA	2034mA	86	±450uF
FED20-24S1P5	18 – 36 V	1.5 V	0mA	6000mA	60mVp-p	35mA	493mA	80	65000uF
FED20-24S1P8	18 – 36 V	1.8 V	0mA	6000mA	60mVp-p	45mA	584mA	81	65000uF
FED20-24S2P5	18 – 36 V	2.5 V	0mA	6000mA	60mVp-p	40mA	781mA	84	33000uF
FED20-24S3P3	18 – 36 V	3.3 V	0mA	5000mA	60mVp-p	30mA	838mA	86	13000uF
FED20-24S05	18 – 36 V	5 V	0mA	4000mA	75mVp-p	35mA	980mA	89	6800uF
FED20-24S12	18 – 36 V	12 V	0mA	1670mA	75mVp-p	55mA	1006mA	87	2200uF
FED20-24S15	18 – 36 V	15 V	0mA	1330mA	75mVp-p	40mA	1002mA	87	755uF
FED20-24D12	18 – 36 V	±12V	0mA	±833mA	100mVp-p	30mA	1004mA	87	±680uF
FED20-24D15	18 – 36 V	±15V	0mA	±667mA	100mVp-p	30mA	993mA	88	±450uF
FED20-48S1P5	36 – 75 V	1.5 V	0mA	6000mA	60mVp-p	15mA	247mA	80	65000uF
FED20-48S1P8	36 – 75 V	1.8 V	0mA	6000mA	60mVp-p	20mA	288mA	82	65000uF
FED20-48S2P5	36 – 75 V	2.5 V	0mA	6000mA	60mVp-p	30mA	391mA	84	33000uF
FED20-48S3P3	36 – 75 V	3.3 V	0mA	5000mA	60mVp-p	15mA	414mA	87	13000uF
FED20-48S05	36 – 75 V	5 V	0mA	4000mA	75mVp-p	20mA	490mA	89	6800uF
FED20-48S12	36 – 75 V	12 V	0mA	1670mA	75mVp-p	35mA	497mA	88	2200uF
FED20-48S15	36 – 75 V	15 V	0mA	1330mA	75mVp-p	50mA	501mA	87	755uF
FED20-48D12	36 – 75 V	±12V	0mA	±833mA	100mVp-p	20mA	496mA	88	±680uF
FED20-48D15	36 – 75 V	±15V	0mA	±667mA	100mVp-p	20mA	496mA	88	±450uF

Notes:

1. MTBF as per BELLCORE TR-NWT-000332. Case 1: 50% Stress, Temperature at 40°C. (Ground fixed and controlled environment).
2. Typical values at nominal input voltage and full resistive load.
3. The ON/OFF control pin voltage is referenced to -Vin.
To order negative logic ON-OFF control add the suffix **-N** (eg: FED20-24S05-N).
4. Heat sink is optional and **P/N: 7G-0020A**.
5. The FED20 series can meet EN55022 Class A with parallel an external capacitor to the input pins.
Recommend: 12Vin : 4.7µF/50V 1812 MLCC, 24Vin : 2.2µF/50V 1812 MLCC, 48Vin : 2.2µF/100V 1812 MLCC.
6. An external filter capacitor is required if the module has to meet EN61000-4-5.
Filter capacitor recommended: Nippon chemi-con KY series, 220µF/100V, ESR 48mΩ.

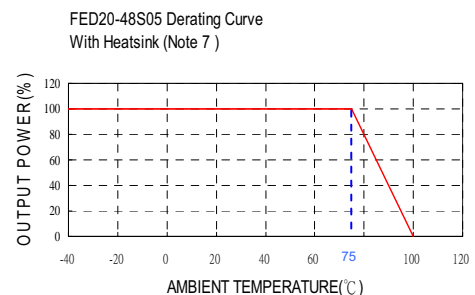
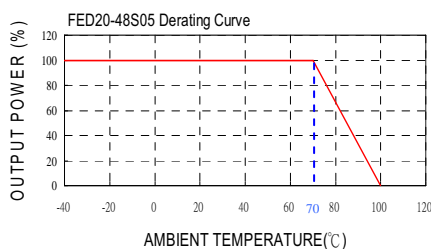

FED20 SERIES

DC / DC Single & Dual Output: 20 Watts

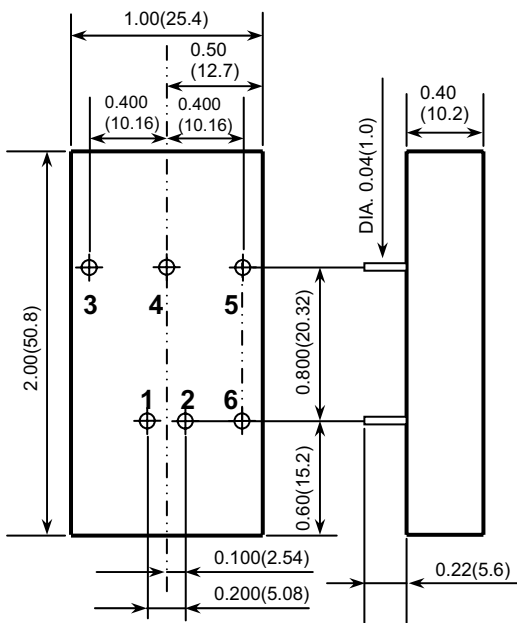
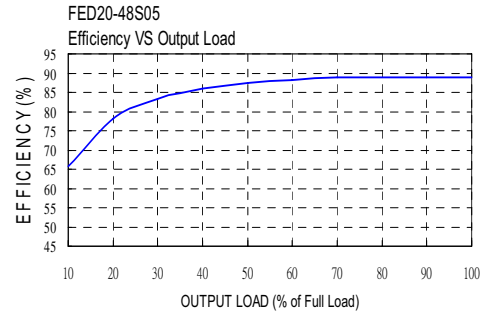
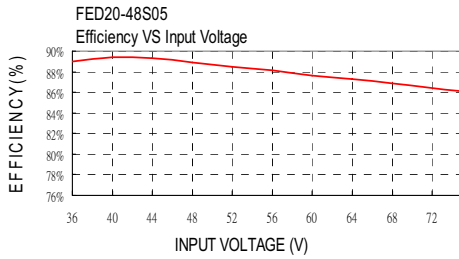

- All dimensions in Inches (mm)
Tolerance: X.XX±0.02 (X.X±0.5)
X.XXX±0.01 (X.XX±0.25)
- Pin pitch tolerance ±0.01(0.25)
- Pin dimension tolerance ±0.004 (0.1)

Pin Assignment		
PIN	SINGLE	DUAL
1	+ Input	+ Input
2	- Input	- Input
3	+ Output	+ Output
4	TRIM	COMMON
5	- Output	- Output
6	CTRL	CTRL

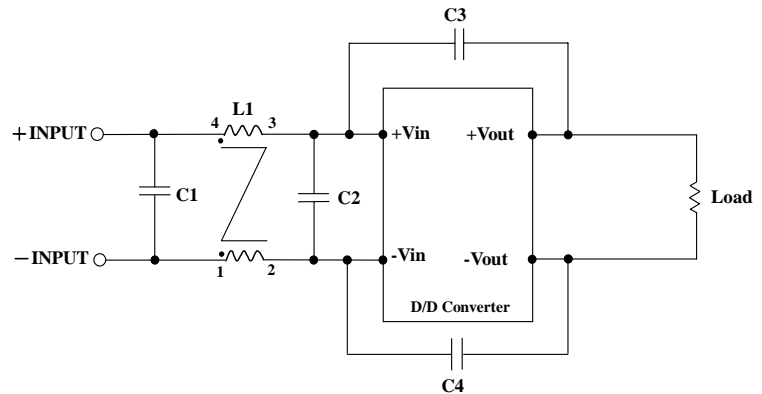
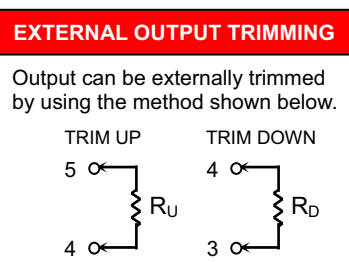

Recommended Filter for EN55022 Class B Compliance

The components used in the above figure, together with the manufacturers' part numbers for these components, are as follows:

	C1	C2	C3	C4	L1
FED20-12xxx	3.3uF/50V 1812 MLCC	3.3uF/50V 1812 MLCC	1000pF/2KV MLCC	1000pF/2KV MLCC	450uH Common Choke PMT-048
FED20-24xxx	4.7uF/50V 1812 MLCC	N/A	1000pF/2KV MLCC	1000pF/2KV MLCC	450uH Common Choke PMT-048
FED20-48xxx	2.2uF/100V 1812 MLCC	2.2uF/100V 1812 MLCC	1000pF/2KV MLCC	1000pF/2KV MLCC	325uH Common Choke PMT-050

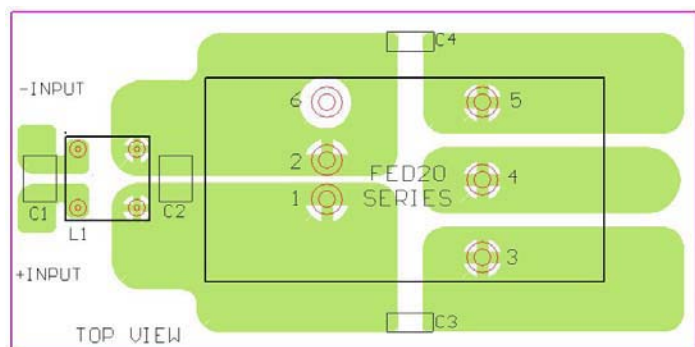

Recommended EN55022 Class B Filter Circuit Layout